

YF-100

Slit Lamp

User Manual



Version: 1.4

Revision Date: 2023. 01

Product Name:	Slit Lamp
Nome do produto:	Lâmpada de fenda
Nombre del producto:	Lampara de hendidura
Ürün Adı:	Biomikroskop
Nome prodotto:	Lampada a fessura
Produktname:	Spaltlampe
Nom du produit:	Lampe à fente
Име на продукта:	Прорезна лампа
Produkto pavadinimas:	Plyšinė lempa
Nazwa produktu:	Lampa szczelinowa
Název produktu:	Štěrbinová lampa
Toote nimi:	Pilu lamp
Produkta nosaukums:	Spraugas lampa
Όνομα προϊόντος:	Σχισμοειδή λυχνία
Numele produsului:	Lampă cu fantă
Productnaam:	Spleetlamp

User Manual Download link:	www.yeasn.com/en/
Link para download do manual do usuário:	www.yeasn.com/en/
Manual de usuario Enlace de descarga:	www.yeasn.com/en/
Kullanım Kılavuzu İndirme linki:	www.yeasn.com/en/
Manuale d'uso Link per il download:	www.yeasn.com/en/
Link zum Herunterladen des Benutzerhandbuchs:	www.yeasn.com/en/
Lien de téléchargement du manuel d'utilisation:	www.yeasn.com/en/
Линк за изтегляне на ръководството за потребителя:	www.yeasn.com/en/
Naudotojo vadovo atsisiuntimo nuoroda:	www.yeasn.com/en/
Link do pobrania instrukcji obsługi:	www.yeasn.com/en/
Uživatelská příručka Odkaz ke stažení:	www.yeasn.com/en/
Kasutusjuhendi allalaadimise link:	www.yeasn.com/en/
Lietotāja rokasgrāmatas lejupielādes saite:	www.yeasn.com/en/
Εγχειρίδιο χρήστη Σύνδεσμος λήψης:	www.yeasn.com/en/
Link de descărcare manual de utilizare:	www.yeasn.com/en/
Gebruikershandleiding Downloadlink:	www.yeasn.com/en/

Preface

Thank you for purchasing and using our Slit Lamp.



Please read this User Manual carefully before using this device. We sincerely hope that this User Manual will provide you with sufficient information to use the device.

Our pursuit is to provide people with high-quality, complete-function and more personalized devices. Information in promotional materials and packing boxes is subject to changes due to performance improvement without additional notice. Chongqing Yeasn Science - Technology Co., Ltd. reserves the rights to update the devices and materials.

If you have any questions during using, please contact at our service hotline: (86-023) 62797666, we will be very happy to help you.

Your satisfaction, our impetus!

Information of manufacturer

Name: CHONGQING YEASN SCIENCE - TECHNOLOGY CO., LTD

Address: 5 DANLONG ROAD, NAN'AN DISTRICT, CHONGQING, CHINA.

Tel: 86-23 62797666

Content

1. Specifications	1
1.1 Uses	1
1.2 Microscope	1
1.3 Slit Illumination.....	1
1.4 Base movement	1
1.5 Chin Rest unit.....	2
1.6 Voltage	2
1.7 Weight and dimension.....	2
1.8 Name plate and indications	2
2. Safety Precautions	4
3. Instrument structure.....	6
4. Installing.....	11
4.1 Parts list	12
4.2 Accessories list	12
4.3 Installing steps	13
4.3.1 Install Head rest unit (C)	13
4.3.2 Install base unit (D)	13
4.3.3 Install Rail cover (E)	14
4.3.4 Install Slit projector unit (B).....	14
4.3.5 Install Eyepiece unit (A).....	15
4.3.6 Install Breath screen (F)	15
4.3.7 Connect the plug.....	16
4.4 Checking after installing.....	16
4.4.1 Power connection	16
4.4.2 Check each unit	16
5. User instruction	17
5.1 Preparation before use	17
5.1.1 Diopter compensation accommodation	17
5.1.2 PD adjustment	18
5.2 Locate the head of the testee.....	19
5.2.1 Locate the head of the testee.....	19
5.2.2 Fix the sight line of the testee.....	19
5.3 Three-dimensional location of the base operation object.....	19

5.4 Illumination adjustment	20
6. Maintenance	22
6.1 Replace Chin-rest papers	22
6.2 Maintenance and care	22
7. Cleaning and protection.....	22
8. Environmental Conditions and Service Life	22
9. Troubleshooting guide	23
10. Circuit diagram.....	24
11. Manufacturer's Responsibility	24
12. Disposal and Environmental protection	24
13. Guidance of EMC and other interference.....	25

1. Specifications

1.1 Uses

For eye examination and aid in the diagnosis.

Contraindications: none.

Target groups of patients: adults, children.

Intended users: optometrists in hospital ophthalmology and optical shops.

The people who use this product are ophthalmologists in hospitals or clinics, and optometrists in optical shops. To operate this product, they should have relevant knowledge of eye examinations and have the relevant skills to operate the product.

1.2 Microscope

- | | |
|-----------------------------|------------------------------|
| 1) Type | Galileo binocular converging |
| 2) Model of magnifying | 5 steps by drum rotation |
| 3) Eyepieces | 12.5× |
| 4) Total magnification rate | 6.4×, 10×, 16×, 25×, 40× |
| 5) Range of PD adjustment | 55mm to 80mm |
| 6) Diopter adjustment | -5.00D to +5.00D |

1.3 Slit Illumination

- | | |
|-------------------|--|
| 1) Slit Width | 0mm to 14mm continuous (become a circle at 14mm) |
| 2) Slit Length | 1mm to 14mm continuous |
| 3) Slit Apertures | φ0.3mm, φ5.5mm, φ9mm, φ14mm |
| 4) Slit Rotation | 0° to 180° continuous adjustable from vertical to horizontal direction |
| 5) Filters | Heat absorption, redfree, cobalt blue |
| 6) Illumination | white LED bulb, brightness adjustable (lx) |

1.4 Base movement

- | | |
|-----------------------------------|-------|
| 1) Longitudinal (In/Out) Movement | 100mm |
| 2) Lateral (Left/Right) Movement | 100mm |
| 3) Vertical (Up/Down) Movement | 30mm |
| 4) Horizontal Movement | 10mm |

1.5 Chin Rest unit

- 1) Chin Rest Elevation 70mm
- 2) Fixation light Red LED

1.6 Voltage

- 1) Power input of adaptor: 100-240 V AC, 50/60 Hz; 1.0-0.5A
- 2) Output of adaptor: 12 V DC 3.34 A; 40 VA
- 3) Output voltage illuminating lamp 3V, fixation point lamp 3V

1.7 Weight and dimension

- 1) Package Dimension 630mm×460mm×400mm
- 2) Overall weight 18.5kg
- 3) Net weight 15 kg

* The design and specifications are subject to changes due to technical updates without additional notice.

1.8 Name plate and indications

Name plate and indications are pasted on the instrument to arise end-users' notice.

In case the name plate is not pasted well or the characters become unclear to recognize, please contact authorized distributors.

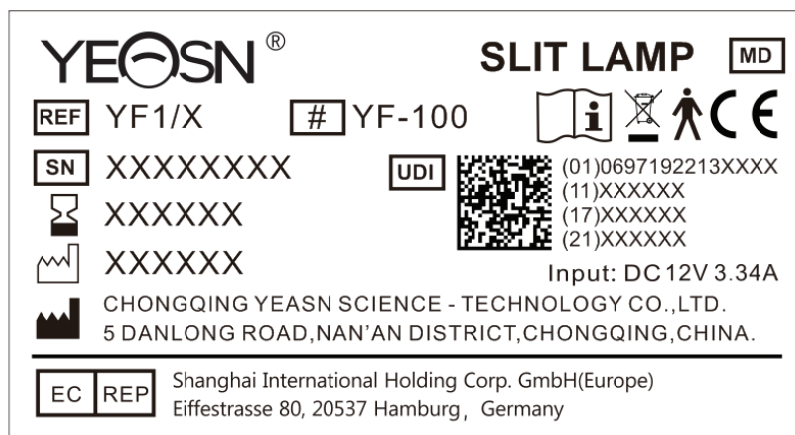

Manufacturer























Date of manufacture



Serial number



Country of manufacture

-  CE marking
-  Correct Disposal of This Product (Waste Electrical & Electronic Equipment)
-  The applied part of the device is Type B (Head rest unit)
-  Medical device
-  Use-by date
-  Consult instructions for use
-  Refer to instruction manual / booklet
-  Authorized European representative
-  Catalogue number
-  Unique Device Identifier
-  Model number
- G.W.** Gross Weight
- DIM.** Dimension
-  Attention! Please refer to accompanying documents
-  Nonionizing radiation
-  Fragile, handle with care
-  This way up
-  Keep dry
-  Do not roll
-  Stacking limit by 5
-  Temperature limit
-  Humidity limitation



Atmospheric pressure limitation

We will make available on request circuit diagrams, component part lists, descriptions that will assist service personnel to repair those parts of ME equipment that are designated by the manufacturer as repairable by service personnel.

2. Safety Precautions

The slit lamp is an instrument consisting of a high-intensity light source that can be focused to illuminate the eyes with a thin beam of light. The binocular slit-lamp examination provides a stereoscopic magnified view of the eye structures, which can be used for examination and auxiliary diagnosis of a variety of eye conditions.



Please read the following matters needing attention carefully in case of personal injury, device damages or other possible hazards:

- To avoid operation in flammable or explosive environment with dust, or high temperatures.

For indoor use only, keep the slit lamp clean and dry.

- To avoid operation near water and prevent any kind of liquid drop on the instrument.
- To avoid place in humid, dusty, or rapid humidity and temperature variation ambient conditions.
- Dedicated power adaptor configured for the device should be used: model GSM40A12 (component of device), Input 100V~240V 50/60Hz, Output 12V 3.34A.
- Do not plug in patch board or power extension cords.
- For emergency situations, cut off the power supply firstly, but avoid pull the power cord.
- Wet hand is not allowed to touch power to avoid shock.

The power cord is forbidden to tread, knot and place heavy object on.

- Not position the device to make it difficult to disconnect the supply mains.
- Check the power cord frequently and before operating to avoid fire and electric shock.
- Disconnect the plug before clean and disinfection.
- Cut off power and put on dust cover when not using it.
- To prevent the instrument from falling and breakdown, it shall be properly installed or placed on a sound and hard surface, with an inclination angle of less than 10°
- Do not disassemble the instrument or change the electrical system.
- In case of moving the installed instrument in short distance, please lock all movable parts. During

movement, please push with hand holding the table top with hand or hold with two hands. If it is long distance movement, please put it back to the original package firstly.

- Electrical medical devices and systems are subject to special EMC measures and must be installed in accordance with the EMC instructions contained in this accompanying document.

- Portable and mobile HF communication systems may interfere with electrical medical devices.

- The operation of other lines or equipment than those listed may lead to higher emissions or may reduce the device's resistance to interference.

- Do not use a power adaptor that is not configured with the device, otherwise it may increase the electromagnetic emission amount, which may reduce the capacity of resisting disturbance.

- In case of a problem, please refer to the troubleshooting guide.

- Do not serviced or maintained while in use with the patient.

- Notification: Any serious event related to the device to the user and/or patient shall be reported to the manufacturer and competent authority of the Member State where the user and/or patient is located.



Caution: The user is cautioned that changes or modifications not expressly approved by the party responsible for compliance could void the user's authority to operate the equipment.

3. Instrument structure

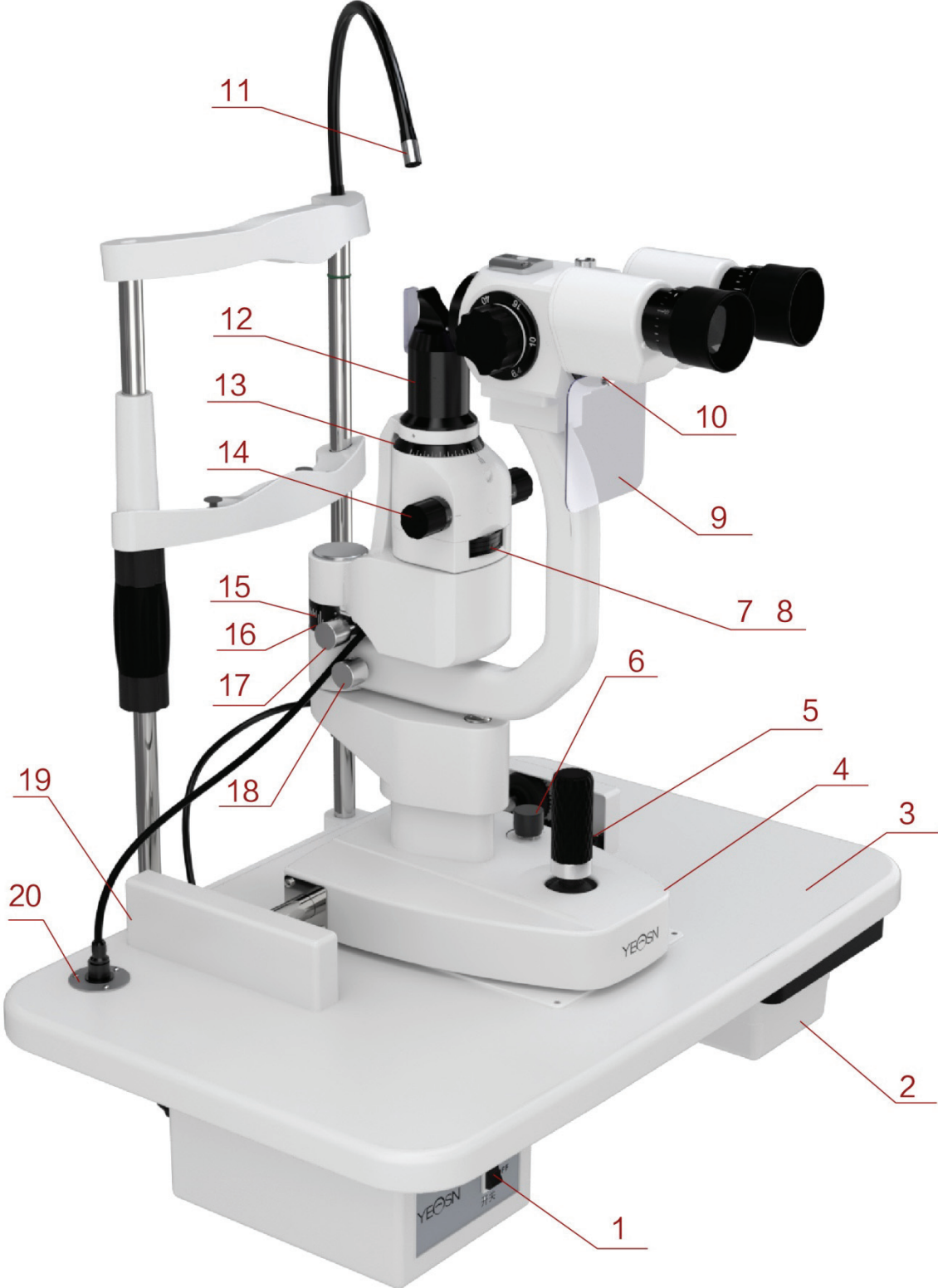

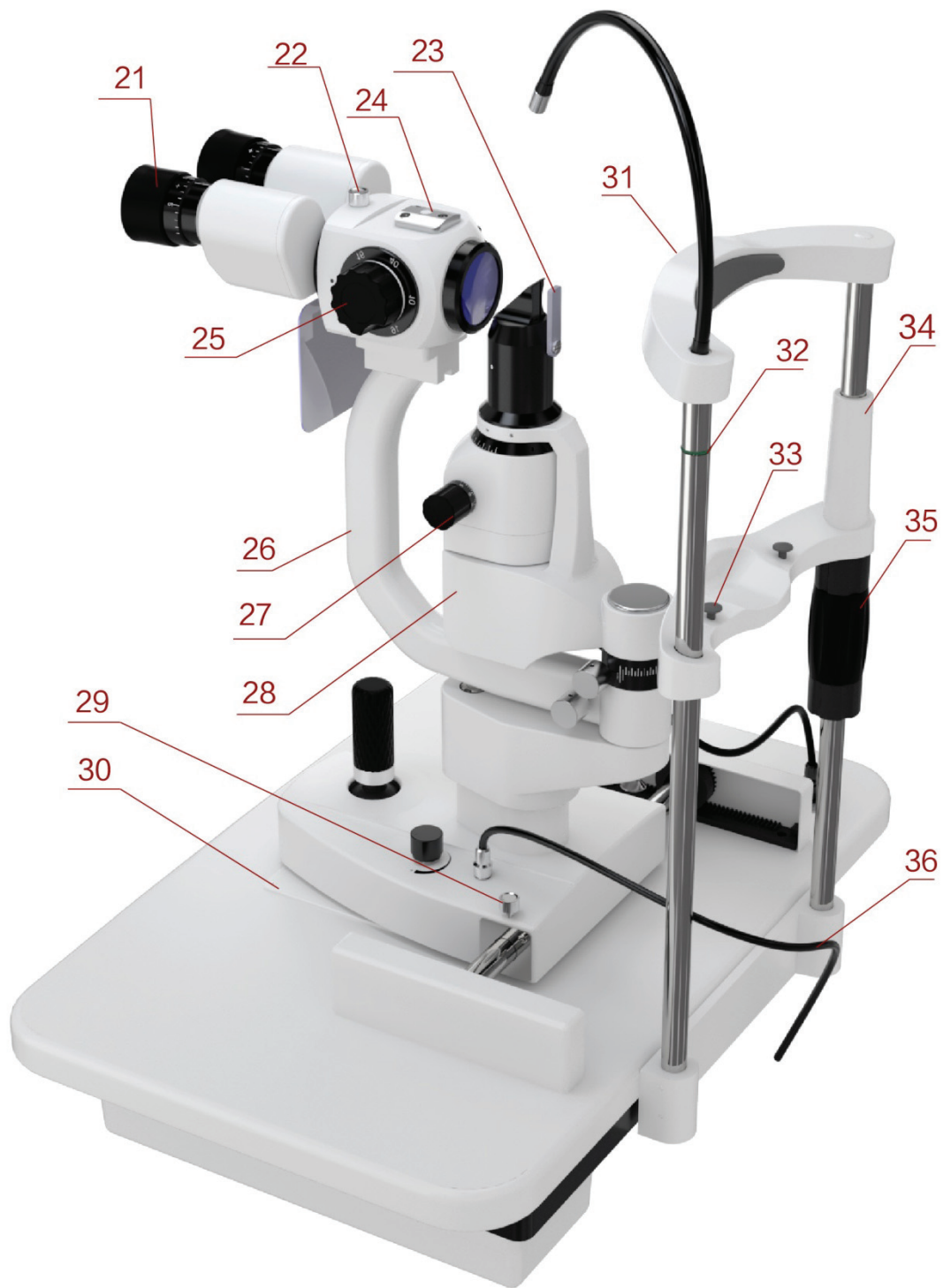

① On/Off Switch

Main power switch of slit lamp.

② Accessories Drawer

Storage the focusing test rod and other accessories.

③ Table top

Mounting substrate of each component,

Platform used by the operator.

④ Base

Supports the microscope and the illumination arms, control the horizontal movement of slit lamp.

⑤ Joystick

Incline joystick to move the instrument slightly in the horizontal surface and rotate it to adjust the elevation of the microscope.

⑥ Intensity Control Knob

Continuous adjustment the illumination.

⑦ Filter Base

Changing filters by turning the base and meet requirement of various inspections.

⑧ Slit Apertures Adjustment Base

Changing the Slit Apertures by turning the base.

⑨ Breath Screen

It can stop the breath between the operator and testee in order to avoid embarrassment.

⑩ Fixing screw for Breath Screen

Install the breath screen.

⑪ Fixation light

Show the eye-gaze direction of testee and position the eyeball of testee.

⑫ Slit Projector Head

The core parts of slit imaging, do not scratch the optical surface in order to avoid effect of image quality.

⑬ Slit Rotation Scale

Indicate the slit rotation angle.

⑭ Slit Width Knob

The slit width is continuous adjustable.

⑮ Illumination Angle Ring

The long line on illumination base and value on corresponding lamination angle ring show the angle of two arms, indicate the angle between observation and illumination direction.

⑯ Illumination Angle Base

⑰ Linkage Knob

Turn this knob, slit projection system and microscope arm are in linkage moving state.

⑱ Microscope Arm Locking Knob

Locks the rotational movement of microscope arm and make it not able to turn in order to make the positioning of observation easily.

⑲ Rail Cover

To protects the rail surface.

⑳ Power socket

Supply power to slit lamp through power cord.

㉑ Focusing Ring

Adjust the eyepiece diopter in order to get clear image before use.

㉒ Connector Locking Knob

When the instrument need maintenance, take apart the observation parts and clean the lens by loose the knob.

㉓ Dispersion Lens

Used for enlarging illumination filed under low magnification ratio.

㉔ Accessory Interface

Installation of tenonmeter and other accessories.

㉕ Magnification dial

Changing the magnification ratio.

②⑥ Moveable Arm

Supporting the observation parts, confirm the observation angle by turning the arm.

②⑦ Slit Base

Change the slit direction by turning the slit base.

②⑧ Illumination Base

②⑨ Instrument Base Locking Knob

Lock the knob, the instrument base will be fixed.

③⑩ Slide Plate

Make the base move by moving joystick on the slide plate.

③⑪ Head Rest

Support the fore head of the testee, position the head of the testee.

③⑫ Eye Position Mark

When the horizontal center of testee' eye in the same horizontal plane of this mark, then the microscope height which controlled by joystick is at the centering position.

③⑬ Chin-Rest Fixed Pin

Fix the paper on the chin-rest.

③⑭ Chin-rest

Support the chin of the testee, position the head of the testee.

③⑮ Chin-rest Adjustment Knob

Adjust the height of chin rest by turning the knob.

③⑯ Illumination cable

4. Installing

This instruction manual is for YF-100 Slit Lamp. All parts must be taken out carefully from the package, and then be put on installing.

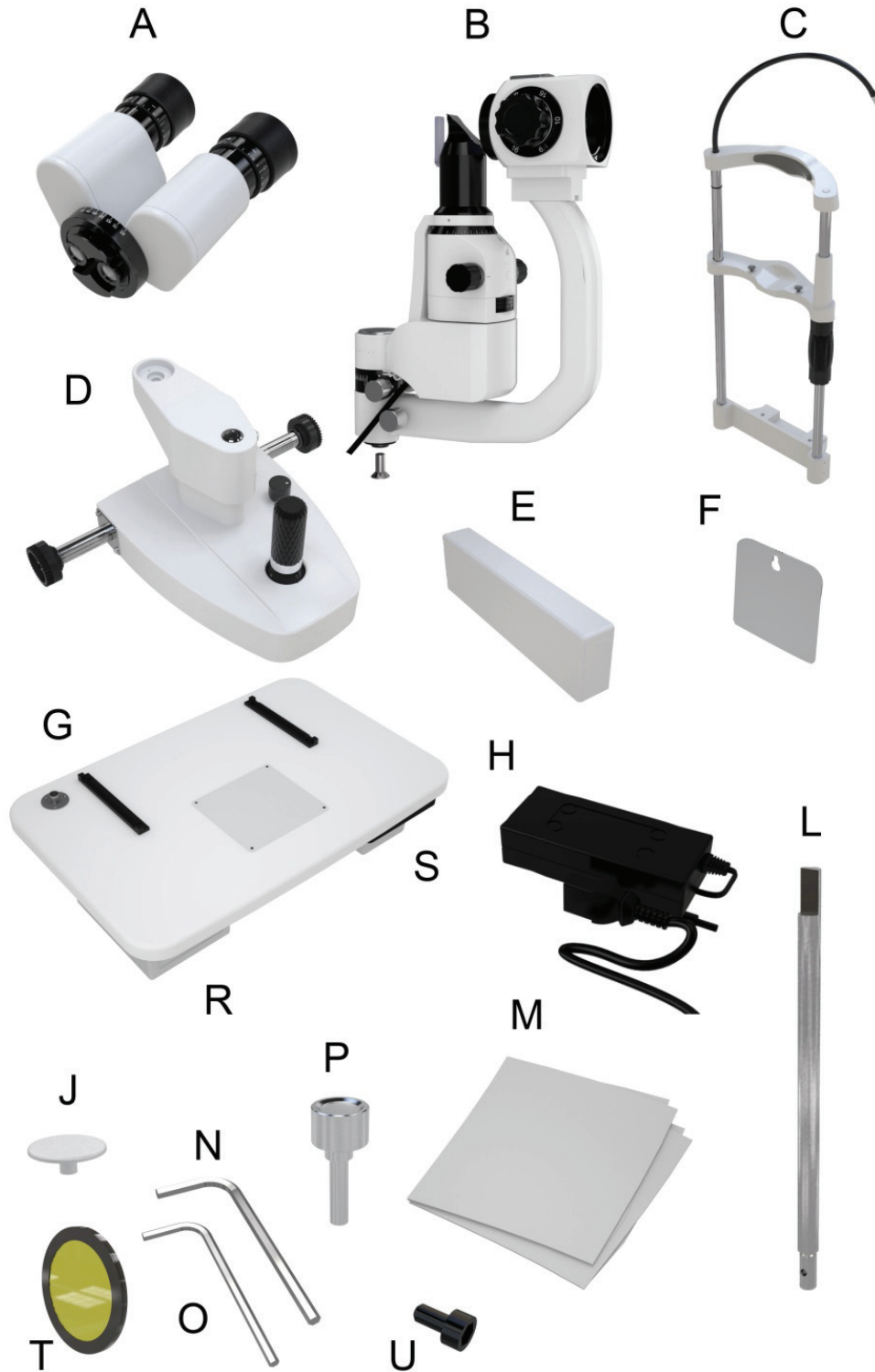

4.1 Parts list

No.	Parts name	Qty.	Note
A	Eyepiece unit	1	
B	Slit projector unit	1	
C	Head rest unit	1	
D	Base unit	1	
E	Rail covers	2	
F	Breath screen	1	
G	Workbench	1	The three units are already installed well into a component
R	Power box	1	
S	Accessories box	1	
H	Power adaptor	1	

4.2 Accessories list

No.	Parts name	Qty.	Note
J	Dust plate	1	
L	Focusing test rod	1	
M	Dust cover	1	
P	Connector locking knob	1	
O	Allen key(4mm)	1	Installing tool
N	Allen key(5mm)	1	Installing tool
T	Yellow filter unit	1	
U	Hexagon socket screw (M5)	2	

4.3 Installing steps

4.3.1 Install Head rest unit (C)

- 1) Place the head rest unit (C) and workbench (G) as shown in Figure 1.
- 2) After aligning the screw holes, use an allen wrench (N) to tighten the two hexagon socket screws (U).



Figure 1

4.3.2 Install base unit (D)

- 1) Install the gear wheels of both sides of Base unit (D) on the gears of workbench (G).
- 2) Note that the gear wheel should be installed in corresponding place of gear (Figure 2), then check if the Base unit (D) can roll steadily forward and backward on workbench (G).
- 3) Connect the Illumination cable.



Figure 2

4.3.3 Install Rail cover (E)

- 1) Align the insert of the rail cover with the groove at the bottom of the rack;
- 2) Insert the rack cover in the direction shown (Figure 3).



Figure 3

4.3.4 Install Slit projector unit (B)

- 1) Drive out the hexagon socket countersunk head screws (Figure 4) beneath the central shaft of Slit projector unit (B) with the allen key (O).



Figure 4

- 2) Connect the central shaft of Slit projector unit (B) to connection base of Base unit (D) , then tighten the hexagon socket (O) countersunk head screws with the allen key (O) (Figure 5).
- 3) Connect the plug below the slit projection part (B) to the corresponding socket above the workbench (G).

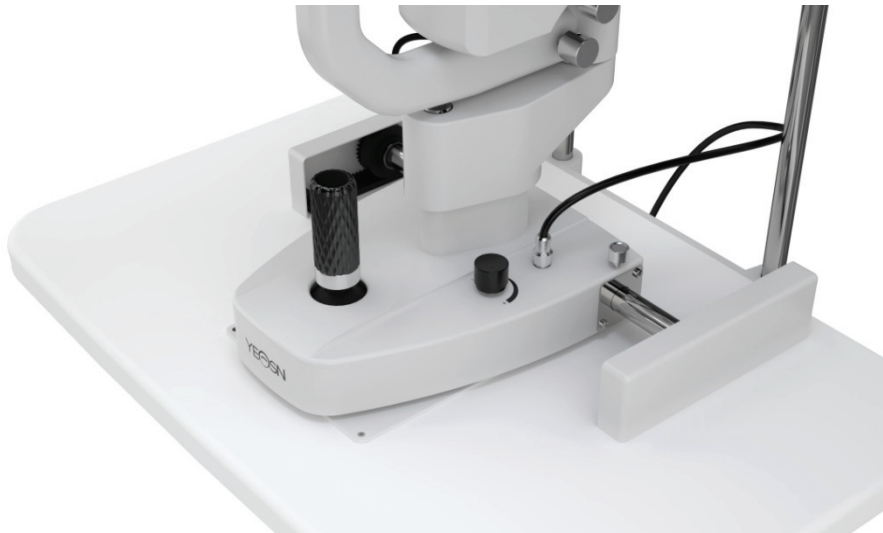

Figure 5



Note: when connecting the central shaft and connection base, the locating pin on connection base should be positioned in the locking slot on the central shaft.

4.3.5 Install Eyepiece unit (A)

Take the Eyepiece unit (A) out carefully; Install the U-groove on the bottom of the Eyepiece unit (A) into the U-guide which supports the bent arm. Tighten the connector locking knob (P) after the front part of U-groove getting close to the connector locking knob (Figure 6).



Note: please do not touch the optical lens in the process of installing Eyepiece unit.



Figure 6

4.3.6 Install Breath screen (F)

- 1) Put the installing hole of breath screen (F) through the hook of the Eyepiece unit (A).
- 2) Strip off the protective film on breath screen. Breath screen can be removed and independently kept when not being used.



Figure 7

4.3.7 Connect the plug

- 1) Connect the plug under the workbench of the workbench (G) to the corresponding socket at the back of the power box (R);
- 2) Connect the plug under the head rest unit (C) to the corresponding socket at the back of the power box (R);
- 3) Connect the plug of the power adapter to the dual-plug power cord, and then connect the dual-plug power cord to the corresponding socket at the back of the power box (R).

4.4 Checking after installing

4.4.1 Power connection

The power adaptor we use is double-pin plug, please check matching.



Note: please use the specialized power cord equipped with the instrument.

4.4.2 Check each unit

- 1) Switch on the power, the indication light of the power adaptor is on.
- 2) Turn the Intensity control knob and see if the illuminating brightness is changing significantly or not.
- 3) Check fixation lamp to see if it works normally.
- 4) Check the flexibility of the aperture base, filter base and slit adjustment knob.
- 5) Switch off the power after finish checking, and then put on dust cover.

5. User instruction

5.1 Preparation before use

5.1.1 Diopter compensation accommodation

1) Insert the focusing test rod into the hole, slightly turn the handle to adjust it until the flat surface facing the objective lens of the Eyepiece unit. (Figure 8)



Figure 8

2) Switch on the power, turn the Intensity control knob, and switch the brightness of slit image on flat surface of the Focusing test rod to the middle grade.

3) Turn the slit adjustment knob, and switch the slit image on the flat surface of the Focusing test rod to about 2 ~ 3mm wide.

4) Rotate the magnification knob to 40 \times .

5) When observing with Eyepiece, switch the control lever for changing enlargement counterclockwise to the end, and then turn clockwise until the image of Focusing test rod becomes clearest. Keep a note of the Diopter compensation value.



Figure 9

6) Repeat the above step, and adjust the other Eyepiece unit. Keep a note of right and left diopter compensation values for reference later.



Note: If the user is emmetropia, you can adjust the diopter compensation value to zero, and then you can see the Focusing test rod is clear.

5.1.2 PD adjustment



Figure 10

1) Hold the left and right prism base cover, observe the slit image on flat surface of the Focusing test rod through left and right eyepieces. Look ahead, you can see two non-overlapping images.

2) Push the prism base cover outward simultaneously until the two slit images overlap and a clear and stereoscopic slit image is formed.



Note: after the diopter compensation and PD adjustment is finished, please remove the Focusing test rod.

5.2 Locate the head of the testee

5.2.1 Locate the head of the testee

- 1) Locate the chin of the testee on the chin-rest unit.
- 2) Slowly turn the chin-rest adjustment knob, and lift the head of the testee until the eyes are at the level of the eye mark.
- 3) Locate the forehead of the testee close to the head rest; make sure the testee head in a comfortable position.



Note: Put a piece of medical gauze on the chin rest before examination.

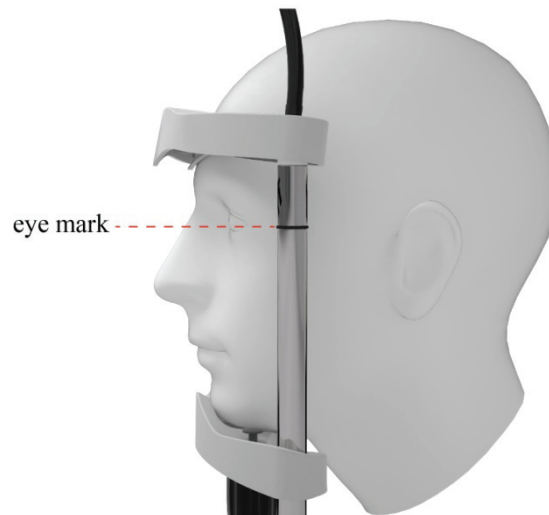

Figure 11

5.2.2 Fix the sight line of the testee

- 1) Ask the testee to stare at the lamp with the spare eye to fix the sight line of the testee.
- 2) Fixation lamp can be turned freely to adjust the sight line of the testee.

5.3 Three-dimensional location of the base operation object

- 1) Rough adjustment in X-Y direction: Operate the joystick on Base unit and keep the joystick vertical. Move the Base unit horizontally to generally target the Eyepiece unit at the object.
- 2) Adjustment in Z direction: rotate the joystick to make the base unit stretch out and draw back in vertical direction so as to adjust the height of Eyepiece unit to target the object (rotate clockwise and the Eyepiece unit lifts, rotate counterclockwise and the Eyepiece unit lowers).
- 3) Fine adjustment in X-Y direction: move the joystick in four direction and the base unit moves

slightly in X-Y direction to make the Eyepiece unit target precisely at the object.

4) Locate the object: after finishing the three steps above, the Eyepiece unit is already targeted at the object in X-Y-Z direction. Fix the base unit by turning the knob on base.

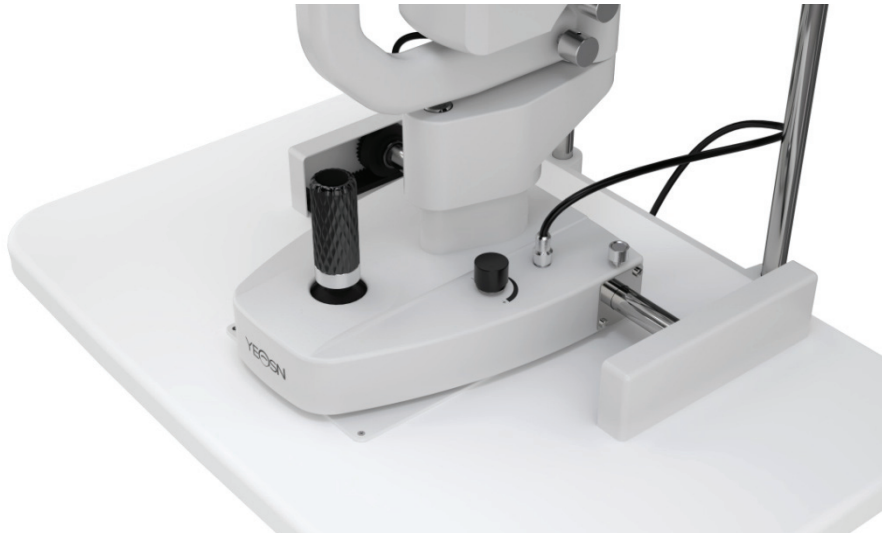

Figure12

5.4 Illumination adjustment

1) Change the width of the slit image: rotate the slit adjustment knob to change the slit width from 0mm to 14mm. (when the width is 14mm, the slit image is round)

2) Change aperture: rotate the aperture base, you can get four different types of round light spot with diameters being 0.3mm/5.5mm/9mm/14mm, and one gear which can change continuously from 1mm to 14mm.

3) Choose filter: rotate the filter base and you can insert three different filters to meet different checking needs. Usually a heat insulation plate is used to make the testee feel comfortable.



Note: different color on filter base means different filters, blue stands for cobalt blue filter, green means redfree filter, orange means heat insulation filter and white means blank filter.



Figure13

4) Rotate the slit image: Rotate the slit base to make the slit image rotate in any degree in horizontal and vertical direction, and the angle can be read on the scale (Figure 14)



Figure 14

5) Insert dispersion lens: when there is need to disperse the illumination light, rotate the dispersion lens into the light path from beneath the slit projector, and rotate it back after finishing it. (Figure 15)



Figure 15

6. Maintenance

6.1 Replace Chin-rest papers

When the chin-rest paper is used up, pull out the two Chin-Rest Fixed Pins, put on new papers. Target the hole and put the Chin-Rest Fixed Pins back.

6.2 Maintenance and care

- 1) Dust and normal saline sometimes go inside the hole of central shaft when using the Slit lamp, please cover the hole with dust cover to save instrument from damage.
- 2) Do not touch the surface of lenses with bare hand or hard objects. Use degreasing cotton dipped in natalite clean fingerprint, dust and blot on the lenses.
- 3) Replaceable repair parts, such as: Eyepiece unit, focusing test rod, power adapter, etc. Do not replace with unauthorized part to avoid any safety risk reduce.
- 4) Do not modify this equipment without authorization of the manufacturer. Installation and repairs may only be performed by trained specialists.

7. Cleaning and protection

1) Cleaning of optical parts: if dusts or dirt stay on the lens or mirror, you can wipe them out lightly with cotton dipped with alcohol.



Note: do not use finger or any hard object to wipe.

2) Clean moving plate, gear and shaft: the movement in horizontal and vertical direction will not be smoothly if the moving plate, gear and shaft are not clean. Then use a clean and soft cloth to wipe it.

3) Clean and disinfection plastics: clean plastic parts such as chin rest, head rest, etc by using soft cloth dipped with soluble detergent or water to clean the dirt, then using medical alcohol to sterilize.





Note: any corrosive detergent is not allowed to use as it may destroy the surface.

4) Put a piece of medical gauze on the chin rest before examination.

8. Environmental Conditions and Service Life

8.1 Environmental conditions for normal operation

 Environment temperature: 10 °C ~ 35 °C

 Relative humidity: 30% ~ 85% (no condensation)

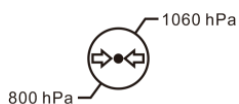

Atmospheric pressure: 800hPa ~ 1060hPa

Indoor conditions: clean and without direct high light.

8.2 Environmental conditions for transportation and storage

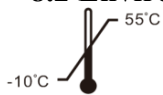

Temperature: -10 °C ~ 55 °C



Relative humidity: 10% ~ 85% (no condensation)

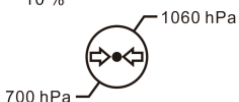

Atmospheric pressure: 700hPa ~ 1060hPa

Please avoid dampness, inversion and heavy shock during transportation.

The instrument should be stored in well-ventilated and non-corrosive indoors.

8.3 Service life

The service life of the device is 8 years from first-time use with proper maintenance and care.

9. Troubleshooting guide

In case of any troubles, please check the list below for guidance. If the trouble is still not solved, please contact Yeasn or its authorized distributor for repair services.

Trouble	Possible cause	Solution
Illumination lamp failure	The power plug is not well connected to socket	Connect the power cord correctly
	The main switch is not turned on	Turn on the switch
	The plug gets loose	Connect the plug tightly
Slit image too dark	The Intensity control knob is on lower gear	Adjust the Intensity control knob
	Dispersion lens or filter in working position	Rotate the dispersion lens or filter out
	Too much dirt on the surface of the reflection mirror	Clean the surface of the mirror
	Dirt on the Eyepiece unit	Clean the surface of the mirror
Fixation lamp failure	The plug on power box gets loose	Connect the plug tightly

10. Circuit diagram

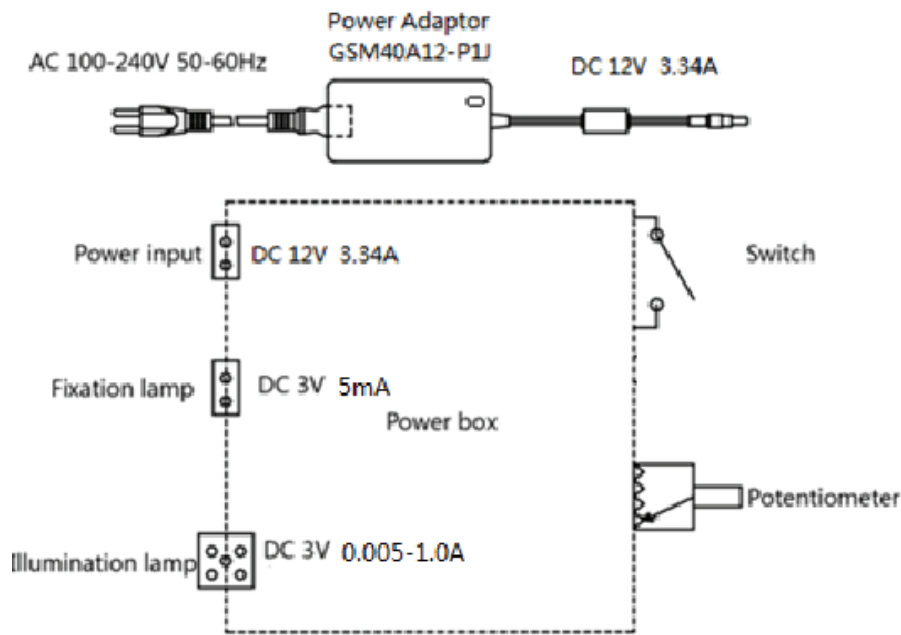

For further information and services, or any questions, please contact with the authorized dealer or manufacturer. We will be happy to help you.

11. Manufacturer's Responsibility

The company is responsible for the safety, reliability and performance impact under below circumstances:

Assembly, addition, modifications, alterations and repairs are carried out by authorized personnel by the company;

Electrical facilities in the room are in conformity with relevant requirements, and

The device is used according to the User Manual.

12. Disposal and Environmental protection



INFORMATION FOR USERS

This product bears the selective sorting symbol for waste electrical and electronic equipment (WEEE). This means that this product must be handled to the local collecting points or given back to retailer when you buy a new product, in a ratio of one to one pursuant to European Directive 2012/19/EU in order to be recycled or dismantled to minimize its impact on the environment.

Very small WEEE (no external dimension more than 25 cm) can be delivered to retailers free of

charge to end-users and with no obligation to buy EEE of an equivalent type. For further information, please contact your local or regional authorities. Electronic products not included in the selective sorting process are potentially dangerous for the environment and human health due to the presence of hazardous substances. The unlawful disposal of the product carries a fine according to the legislation currently in force.

13. Guidance of EMC and other interference

- 1) This product needs special precautions regarding EMC and needs to be installed and put into service according to the EMC information provided, and this unit can be affected by portable and mobile RF communications equipment.
- 2) Do not use a mobile phone or other devices that emit electromagnetic fields, near the unit. This may result in incorrect operation of the unit.
- 3) Caution: This unit has been thoroughly tested and inspected to assure proper performance and operation.
- 4) Caution: this machine should not be used adjacent to or stacked with other equipment and that if adjacent or stacked use is necessary, this machine should be observed to verify normal operation in the configuration in which it will be used.

Guidance and manufacture’s declaration – electromagnetic emission		
The YF-100 is intended for use in the electromagnetic environment specified below. The customer of the user of the YF-100 should assure that it is used in such an environment.		
Emission test	Compliance	Electromagnetic environment – guidance
RF emissions CISPR 11	Group 1	The YF-100 use RF energy only for its internal function. Therefore, its RF emissions are very low and are not likely to cause any interference in nearby electronic equipment.
RF emission CISPR 11	Class A	The YF-100 is suitable for use in all establishments, other than domestic and those directly connected to the public low-voltage power supply network that supplies buildings used for domestic purposes.
Harmonic emissions IEC 61000-3-2	Class A	
Voltage fluctuations/ flicker emissions IEC 61000-3-3	Complies	

Guidance and manufacture's declaration – electromagnetic immunity

The YF-100 is intended for use in the electromagnetic environment specified below. The customer or the users of YF-100 should assure that it is used in such an environment.

Immunity test	IEC 60601 test level	Compliance level	Electromagnetic environment - guidance
Electrostatic discharge (ESD) IEC 61000-4-2	±8 kV contact ±15 kV air	±8 kV contact ±15 kV air	Floors should be wood, concrete or ceramic tile. If floors are covered with synthetic material, the relative humidity should be at least 30%.
Electrical fast transient/burst IEC 61000-4-4	±2 kV for power supply lines ±1 kV for input/output lines	±2 kV for power supply lines	Mains power quality should be that of a typical commercial or hospital environment.
Surge IEC 61000-4-5	± 1 kV line(s) to line(s) ± 2 kV line(s) to earth	±1 kV differential mode ±2 kV common mode	Mains power quality should be that of a typical commercial or hospital environment.
Voltage dips, short interruptions and voltage variations on power supply input lines IEC 61000-4-11	<5% U_T (>95% dip in U_T) for 0.5 cycle 40% U_T (60% dip in U_T) for 5 cycles 70% U_T (30% dip in U_T) for 25 cycles <5% U_T (>95% dip in U_T) for 5 sec	<5% U_T (>95% dip in U_T) for 0.5 cycle 40% U_T (60% dip in U_T) for 5 cycles 70% U_T (30% dip in U_T) for 25 cycles <5% U_T (>95% dip in U_T) for 5 sec	Mains power quality should be that of a typical commercial or hospital environment. If the user of the YF-100 requires continued operation during power mains interruptions, it is recommended that the YF-100 be powered from an uninterruptible power supply or a battery.
Power frequency (50Hz/60Hz) magnetic field IEC 61000-4-8	3 A/m	3 A/m	Power frequency magnetic fields should be at levels characteristic of a typical location in a typical commercial or hospital environment.

NOTE U_t is the a.c. mains voltage prior to application of the test level.

Guidance and manufacture's declaration – electromagnetic immunity

The YF-100 is intended for use in the electromagnetic environment specified below. The customer or the user of the YF-100 should assure that it is used in such an environment.

Immunity test	IEC 60601 test level	Compliance level	Electromagnetic environment - guidance
<p>Conducted RF IEC 61000-4-6</p>	<p>3 V_{rms} 150 kHz to 80 MHz</p>	<p>3 V_{rms}</p>	<p>Portable and mobile RF communications equipment should be used no closer to any part of the YF-100, including cables, than the recommended separation distance calculated from the equation applicable to the frequency of the transmitter. Recommended separation distance</p> $d = 1,2\sqrt{P}$
<p>Radiated RF IEC 61000-4-3</p>	<p>3 V/m 80 MHz to 2.5 GHz</p>	<p>3 V/m</p>	<p>$d = 1,2\sqrt{P}$ 80 MHz to 800 MHz</p> <p>$d = 2,3\sqrt{P}$ 800 MHz to 2,5 GHz</p> <p>Where P is the maximum output power rating of the transmitter in watts (W) according to the transmitter manufacturer and d is the recommended separation distance in metres (m). Field strengths from fixed RF transmitters, as determined by an electromagnetic site survey,^a should be less than the compliance level in each frequency range.^b Interference may occur in the vicinity of equipment marked with the following symbol:</p> 

NOTE1 At 80 MHz and 800 MHz, the higher frequency range applies.

NOTE2 These guidelines may not apply in all situations. Electromagnetic propagation is affected by absorption and reflection from structures, objects and people.

a Field strengths from fixed transmitters, such as base stations for radio (cellular/cordless) telephones and land mobile radios, amateur radio, AM and FM radio broadcast and TV broadcast cannot be predicted theoretically with accuracy. To assess the electromagnetic environment due to fixed RF transmitters, an electromagnetic site survey should be considered. If the measured field strength in the location in which the YF-100 is used exceeds the applicable RF compliance level above, the YF-100 should be observed to verify normal operation. If abnormal performance is observed, additional measures may be necessary, such as re-orienting or relocating the YF-100.

b Over the frequency range 150 kHz to 80 MHz, field strengths should be less than 3 V/m.

**Recommended separation distances between
portable and mobile RF communications equipment and the YF-100**

The YF-100 is intended for use in an electromagnetic environment in which radiated RF disturbances are controlled. The customer or the user of the YF-100 can help prevent electromagnetic interference by maintaining a minimum distance between portable and mobile RF communications equipment (transmitters) and the YF-100 as recommended below, according to the maximum output power of the communications equipment.

Rated maximum output power of transmitter (W)	Separation distance according to frequency of transmitter (m)		
	150 KHz to 80 MHz $d = 1,2\sqrt{P}$	80 MHz to 800 MHz $d = 1,2\sqrt{P}$	800 MHz to 2.5 GHz $d = 2,3\sqrt{P}$
0.01	0.12	0.12	0.23
0.1	0.38	0.38	0.73
1	1.2	1.2	2.3
10	3.8	3.8	7.3
100	12	12	23

For transmitters rated at a maximum output power not listed above, the recommended separation distance d in metres (m) can be estimated using the equation applicable to the frequency of the transmitter, where P is the maximum output power rating of the transmitter in watts (W) according to the transmitter manufacturer.

NOTE 1 At 80 MHz and 800 MHz, the separation distance for the higher frequency range applies.

NOTE 2 These guidelines may not apply in all situations. Electromagnetic propagation is affected by absorption and reflection from structures, objects and people.